

Design of High Gain Slotted Circular Microstrip Antenna for X-band Applications

Riyam A. Mutashar*, Akeel S.Tahir, Wa'il A. Godaymi Al-Tumah
Department of Physics, College of Science, University of Basrah, Basra, Iraq

*Corresponding author E-mail: am2010r@yahoo.com

Doi:10.29072/basjs.20213016

Abstract

In this study, new structures of circular microstrip antennas, which operating in X-band frequency using etched slots on the patch radiating, are designed and simulated. These slots are rectangular and crescent shapes in different sizes. The proposed structures are fed by a coaxial line feed. The antennas designed are simulated and studied in order to obtain the optimum performance of the proposed antenna using Ansoft High Frequency Structure Simulator. The simulated results were discussed in terms of reflection coefficient, input impedance, gain, radiation patterns and surface currents. It is found that the optimum antenna design has resonance frequency 9.346 GHz with a bandwidth of reflection coefficient of 705 MHz, which is required for X-band applications. Therefore, this optimum designed is helpful for many applications in the system of modern wireless communication.

Article inf.

Received:

4/9/2021

Accepted:

13/10/9/2021

Published:

31/12/2021

Keywords:

Microstrip
Antenna; Circular
Patch; x-band;
Slot Antenna;
HFSS



1. Introduction

Microstrip antennas (MSAs) are widely used in wireless communication, satellite communication and in many fields of electromagnetic application due to their light weight, easy fabrication, low-profile conformal design, and inexpensive design [1-3]. Therefore, many researchers are working to increase the performance of these antennas using different types of dielectric substrate and new modification on conducting patch [4-9]. MSA is one of antenna types of planar structure which consists of three layers and known as printed antennas [10-11]. These layers are a radiating patch of conducting layer on one side of a dielectric substrate layer and a ground plane of conducting layer on the other side of this substrate [12]. The patch layers have various regular and irregular shapes according to the desired application. The regular patch shapes are circular, rectangular, annular, elliptic, square and etc. The regular patch antennas are more common, mainly because ease of fabrication and design. Also, these shapes have been widely studied and the design procedures are well established [13-14]. Moreover, they are used as conformal antennas for airplanes, cars, missiles, portable devices and many other applications. While, the irregular shape of patch antenna is designed to achieve a desire feature of antenna parameters such as multi-frequency operation and wide bandwidth [15-16]. In MSAs, several shapes of the conducting patch are using to improve the antenna performance. The directivity and gain are important features for any antenna design. Therefore, in fixed wireless local area network (WLAN) application and satellite communications systems, antenna of high directivity and gain is required [17-22]. Also, can be increased these two characteristics using array of MSAs [23]. In general, MSAs have low gain and narrow bandwidth. However, to control this weakness in these antennas, several various methods have been suggested, like using proximity feeding, different shapes for patch, defected ground structures, metamaterials, stacked patch, fractal, using thick dielectric substrate with low permittivity and multimode techniques and etched slots on the conducting patch with various shapes [24-27]. To obtain high antenna performance, the dielectric substrate should be thick [28]. Also, it is desirable to have a lower dielectric constant for improved efficiency, increased radiation and bandwidth. But a larger antenna is required for such a configuration. On the other hand, if we use small size MSA, the efficiency, gain and bandwidth will be reduced due to minimize the antenna size. Hence, there is always a trade-off between antenna dimensions and performance. Therefore, the researchers focused on the modification in the patches using slots, dual patch, dual dielectric layers, and etc. [29].



Electromagnetic energy in the MSA is directed to the patch antenna from excitation of negative charges (which are produced at the feed point) and positive charges (which are generated in other parts of the patch) [30]. Hence, the main radiation in MSAs is caused from the fringing fields between the ground plane and patch edges [31].

In this work, circular microstrip antennas (CMSA) based on etched slots on the circular patch radiating are proposed and operating in the X-band frequency, which has the range frequency of 8.0-12.0 GHz. These antennas are designed and simulated using Ansoft High Frequency Structure Simulator and the optimum antenna design is useful for X-band applications. This band has widely used in radar applications because its wave characteristics have short wavelengths and high transmission rates. These two features allow researchers to use X-band frequencies in medical, military, aerospace, and high-resolution imaging communications for target discrimination and identification [1].

2. Antenna Design

The performance of MSAs is mainly affected by the choosing of conducting patch design through changing radiation pattern, surface current distribution, gain, bandwidth and impedance matching. Therefore, this study aims to obtain more efficient and easy ways to realize the required results such as gain and bandwidth. A CMSA is used as the first step to design the suggested antenna. Also, several design steps are used to reach to the optimum performances of the proposed antenna. Figure 1 shows the geometry design of proposed antenna. The novelty of this antenna is based on etched slots on the conducting patch of CMSA. Fig. (1A) shows the first step, two rectangular slots with the same diminutions are etched on the edge of the antenna. In the next step, one crescent slot is etched on the half of patch (see Fig. (2A)). The third step is added additional one crescent slot (see Fig. (3A)). In the fourth step, the two crescent slots are modified to become parts of circle (see Fig. (4A)). In the last two steps, two rectangular slots are etched next to the curve and straight edges of the two parts of circle slots, as shown in Fig (5A) and (6A), respectively.

The proposed antenna is constructed on Roger RT (Duroid 5870) as a dielectric substrate with thickness $h=1.5$ mm and dielectric constant $\epsilon_r = 2.33$. The circular patch having a radius $a= 5.5$ mm. The outer and inner radii of coaxial line are ($r_o=2.5$ mm) and ($r_i=1$ mm), respectively.



However, Table 1 and Fig. (2) displayed the optimum dimensions and geometrical shape of the proposed antenna, respectively. Also, this proposed antenna is resonant at x-band.

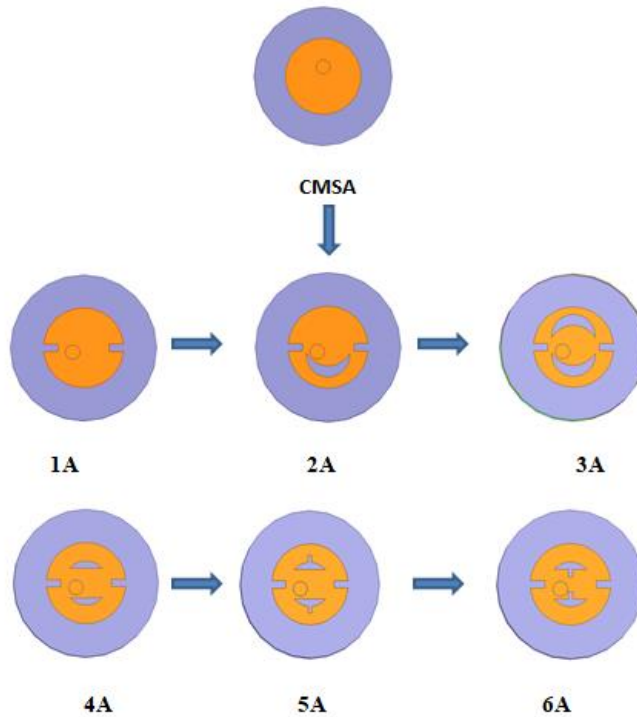

Figure 1: Geometry Shapes of etched slots on the proposed patch antenna.

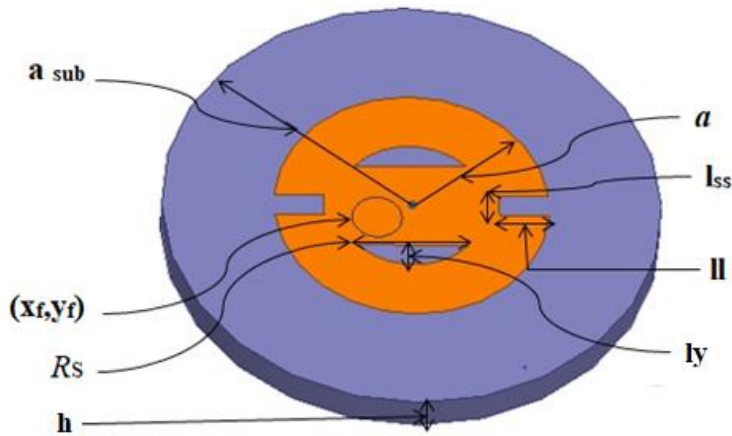

Figure 2: Geometry dimensions of the optimum antenna design.

Table 1: Dimensions of the optimum antenna design.

Parameters	Dimension (mm)
a_{sub}	10.0
a	5.5
h	1.5
l_l	2.0
l_{ss}	1.0
l_y	1.0
R_s	4.3
(x_f, y_f)	(-1.4, 0.6)

The initial design of the proposed antenna is obtained by following the basic procedure of CMSAs. This procedure starts with apply the following equation to specified the resonance frequency [32]:

$$f_{nm} = \frac{\chi_{nm} c}{2\pi a_e \sqrt{\epsilon_r}} \quad (\text{GHz}) \quad (1)$$

Where f_{nm} is the resonance frequency, χ_{nm} refers to the roots of Bessel function derivatives. The Subscripts n and m are referred to the order of Bessel function derivatives and its roots, respectively. Both c and ϵ_r refer to light speed (in free space) and dielectric constant of dielectric substrate, respectively. While a_e is the effective radius of a circular patch and is given by [32]:

$$a_e = a \left[1 + \frac{2h}{\pi \epsilon_r a} \left(1.7726 + \ln \left(\frac{a\pi}{2h} \right) \right) \right]^{1/2} \quad (2)$$

3. Results and Discussion



In this section, the simulation results of the proposed antennas are presented using the software Ansoft HFSS. These antennas are printed on the Roger RT (Duroid 5870) as a cost efficient, with radius $a_{sub} = 10$ mm and dielectric constant $\epsilon_r = 2.33$ with a coaxial probe as a feeder, (see Figs. 1&2). Figure 3 displays the simulation results of the reflection coefficient of these antennas. It is possible to note from this figure that the antenna designed in Fig. (1, 4A) has the best results with bandwidth 705 MHz. Therefore, this design is the optimum antenna design and has the resonance frequency 9.346 GHz with return loss value -36.755 dB.

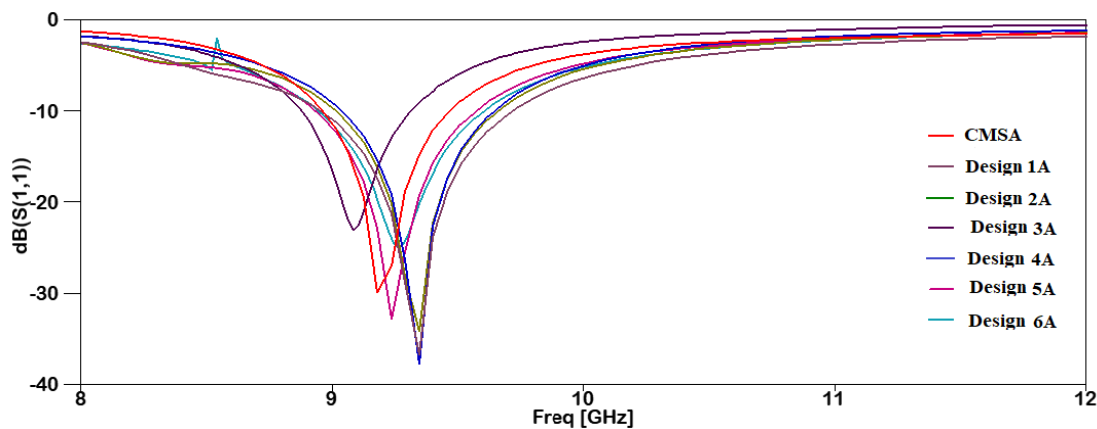

Figure 3: Simulation findings of the reflection coefficient for designed antennas in Fig. 1.

Figure 4 shows the comparison of the simulation VSWR values of the antennas designed in Fig. (1). From Fig. (4), the antenna designed in Fig. (1, 4A) has the minimum value of VSWR and its equal to 1.0399 at resonant frequency 9.346 GHz.

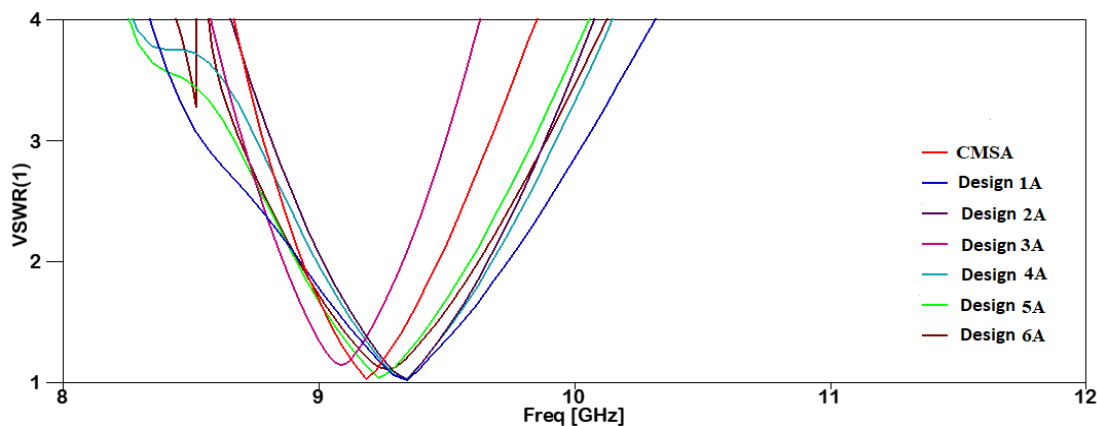

Figure 4: Simulation findings of VSWR for designed antennas in Fig. 1.



The simulation findings of the input impedance (Z_{in}) for the antennas designed in Fig. (1) are illustrated in Fig. (5). It can be concluded from this figure, the antenna designed in Fig. (1, 4A) has input impedance value (50.66, 1.77) Ω at the operating frequency 9.346 GHz which is the best value of Z_{in} .

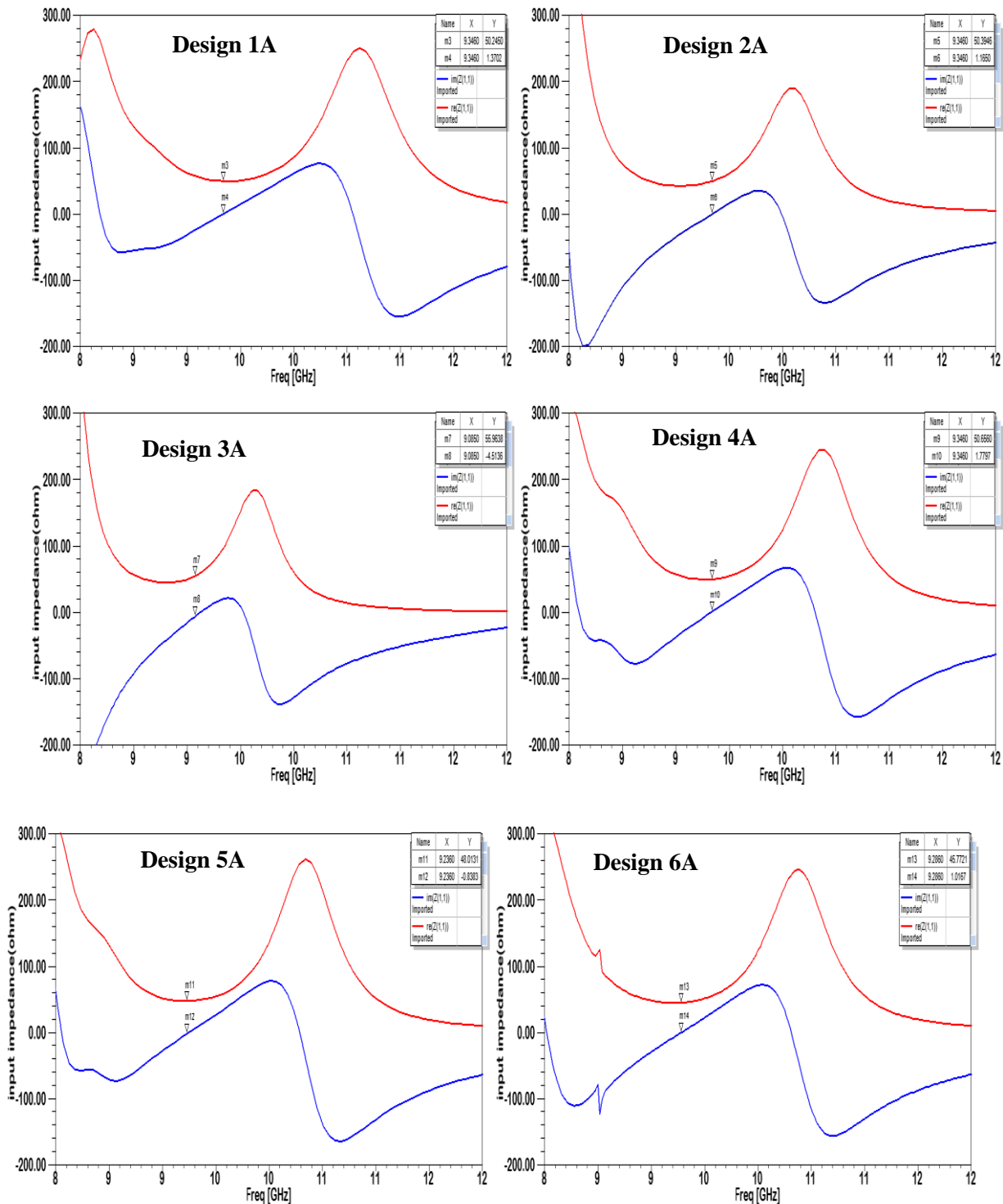
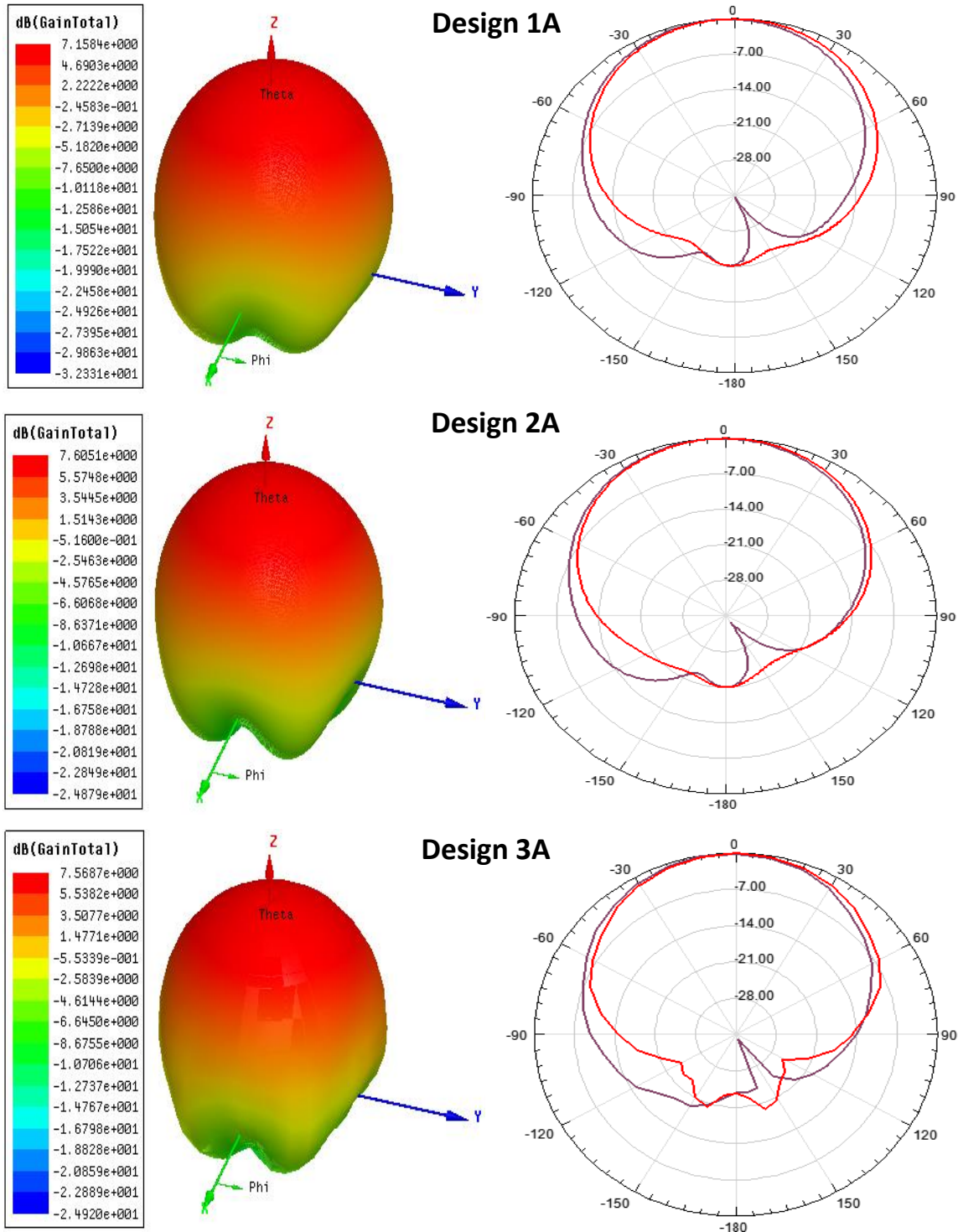

Figure 5: Simulation results of the input impedance for designed antennas in Fig. 1.



The Simulation results of the radiation patterns in the two and three dimensions for the designed antennas in Fig. 1 are shown in Fig. (6). From this figure the antenna designed in Fig. (1, 4A) has the maximum gain 7.843 dB at the operating frequency 9.346 GHz.



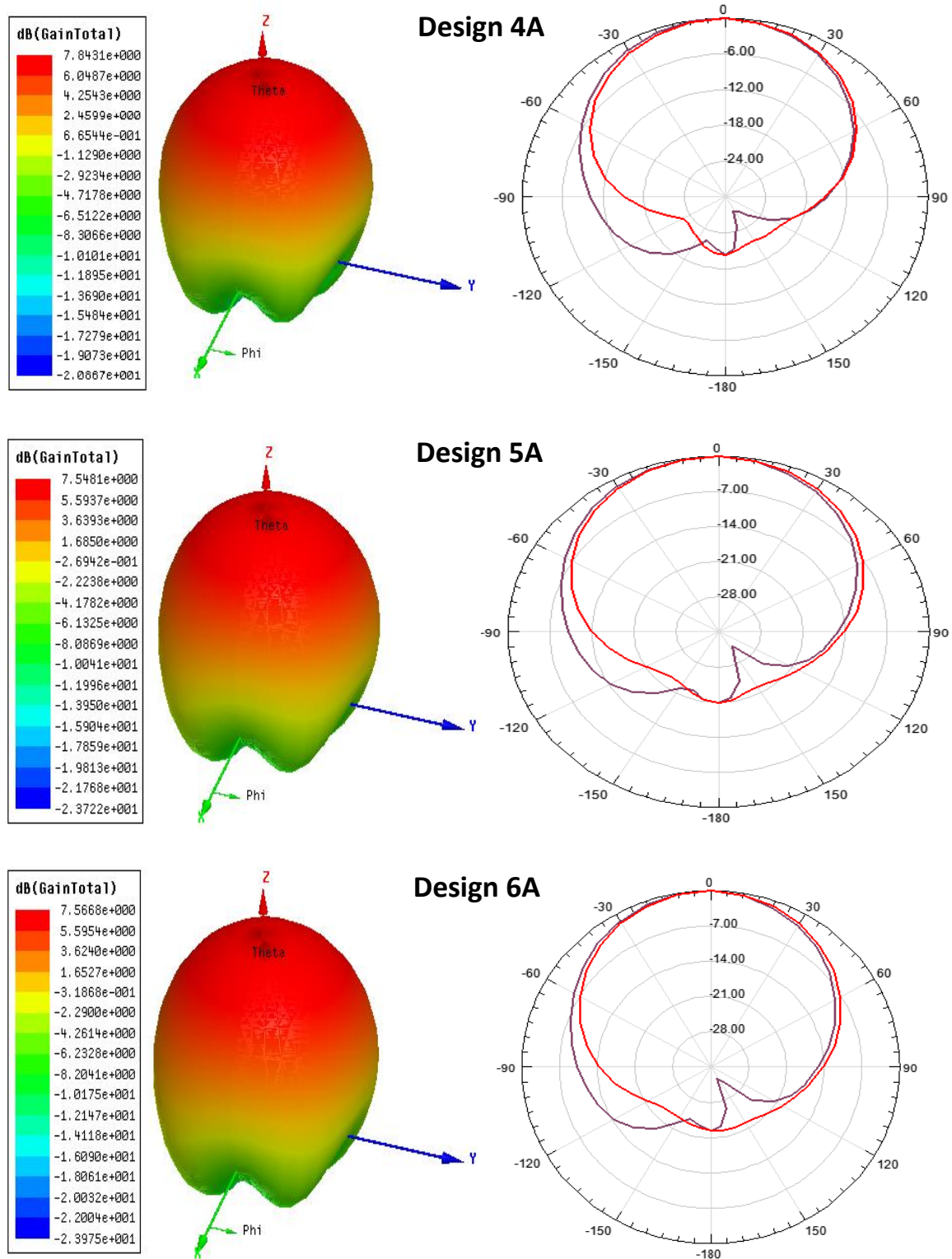

Figure 6: Simulation radiation patterns in the two and three dimensions for designed antennas in Fig. 1. (E-plane red curve and H-plane black curve).



Table 2 illustrates the comparison of the simulation parameters of designed antennas in Fig. (1) such as resonant frequency, return loss, VSWR, bandwidth, gain, impedance bandwidth and the feed location. From this table, the antenna designed in Fig. (1, 4A) is the optimum designed. Therefore, some parametric study for l_{ss} , l_l , l_y and x_f is carried out on S11, VSWR, BW, Z_{in} and radiation pattern. Table 3 illustrates the effect of various value of dimension l_{ss} on the antenna parameters. Hence, the best findings of these parameters can be obtained at $l_{ss}=1.0$ mm. Also, Fig. (7) shows the simulation results of radiation patterns in H- and E-planes for different dimension of l_{ss} .

Table 2 Comparison of the simulation parameters of designed antennas in Fig. (1).

Antenna design	f_r (GHz)	S11 (dB)	VSWR	BW (dB)	Gain (dB)	Z_{in} (Ω)	Feed point (mm)
CMSA	9.18	-29.66	1.033	499	5.908	(49.04,-0.9)	(-1.35,0.0)
1A	9.346	-34.162	1.029	641	7.158	(50.24, 1.37)	(-1.4,0.6)
2A	9.346	-37.69	1.026	587	7.605	(50.42,1.23)	(-1.6,0.6)
3A	9.085	-23.040	1.1516	435	7.568	(55.99,-4.46)	(-1.5,0.6)
4A	9.346	-36.755	1.0399	705	7.843	(50.66, 1.77)	(-1.4,0.6)
5A	9.236	-33.17	1.044	633	7.548	(48.01,-0.83)	(-1.4,0.6)
6A	9.286	-26.846	1.099	652	7.566	(45.59, 1.01)	(-1.4,0.6)

Table 3: Effect of various value of dimension l_{ss} on the optimum designed.

l_{ss} (mm)	f_r (GHz)	S11 (dB)	VSWR	BW (MHz)	Z_{in} (Ω)
0.6	8.959	-31.16	1.056	620	(50.07,-2.86)
0.8	8.628	-34.04	1.040	520	(51.98,0.40)
1.0	9.346	-34.16	1.039	705	(50.65,1.77)
1.2	8.738	-29.89	1.066	552	(52.62,-2.09)
1.4	8.517	-26.26	1.102	497	(52.48,4.25)



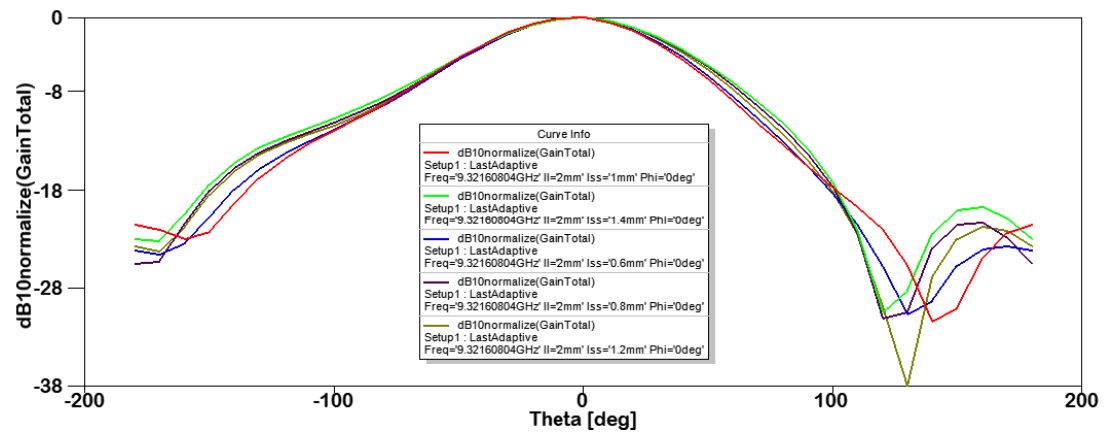

(a)

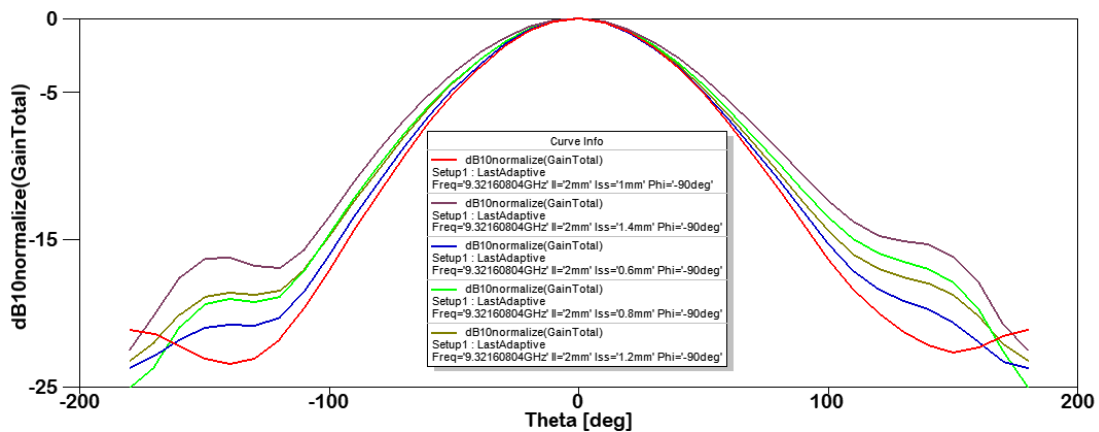

Figure 7: Simulation results of radiation pattern at resonant frequency 9.346 GHz in (a) H-plane and (b) E-plane.

Similarly, Table 4 illustrates the effect of various value of dimension l_2 on the antenna parameters. This table shows that the best findings of these parameters can be obtained at $l_2=2.0$ mm. Also, Fig. (8) shows the simulation results of radiation patterns in H- and E-planes for different dimension of l_2 .



Table 4: Effect of various value of dimension ll on the optimum designed.

ll (mm)	f _r (GHz)	S11 (dB)	VSWR	BW (MHz)	Z _{in} (Ω)
1.6	9.291	-33.00	1.044	628	(48.0,0.75)
1.8	9.346	-34.32	1.039	629	(48.1,-0.61)
2.0	9.346	-34.16	1.039	705	(50.65,1.77)
2.2	10.175	-37.81	1.026	1127	(50.88,1.60)
2.4	9.291	-30.7	1.060	595	(50.34,-2.95)

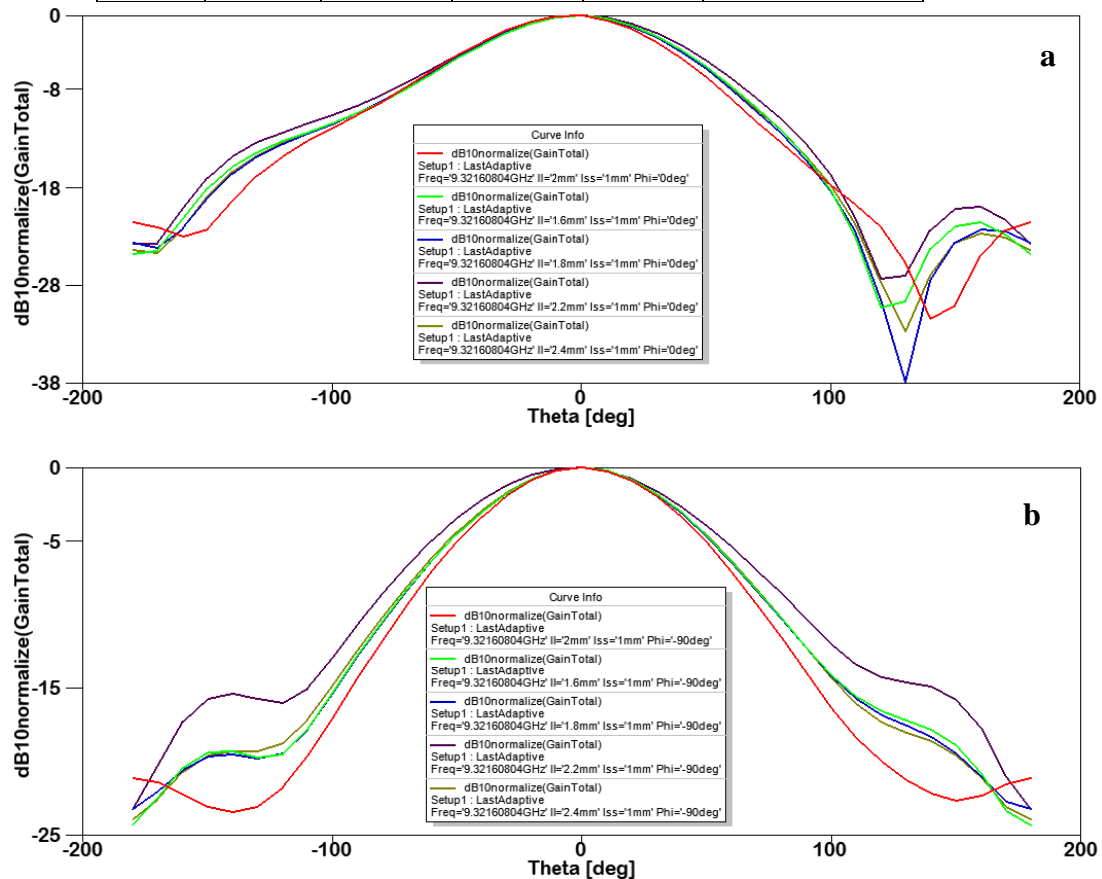

Figure 8: Simulation results of radiation pattern at resonant frequency 9.346 GHz in (a) H-plane and (b) E-plane.

The dimension l_y has no effect on the antenna parameters. Fig. (9) shows the simulation results of return loss for different dimension of l_l .

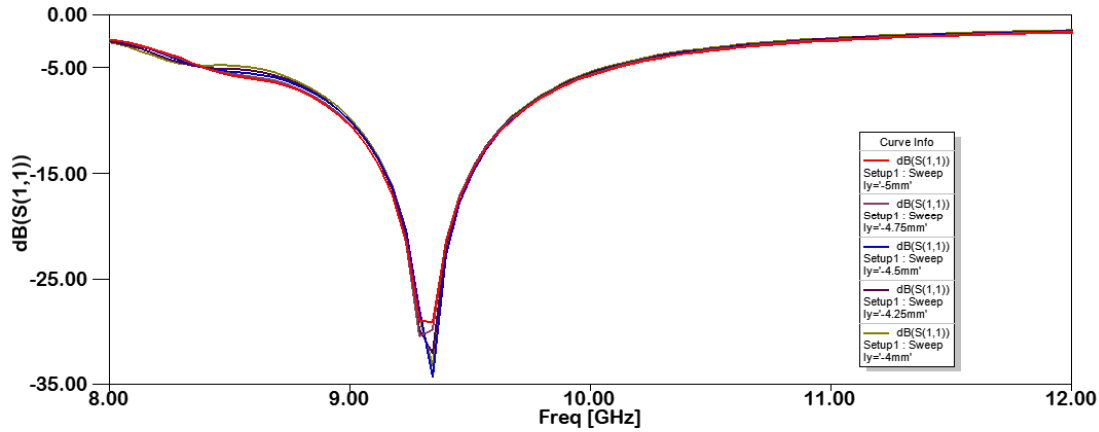

Figure 9: Simulation results of return loss for various value of dimension l_y .

To study the effect of feed point location x_f on the antenna parameters. Table 5 displays the effect of various value of x_f on these parameters. This table shows that the best findings of these parameters can be obtained at $x_f = -1.4$ mm.

Table 5: Effect of various value of feed point location x_f on the optimum designed.

x_f (mm)	f_r (GHz)	S11 (dB)	VSWR	BW (MHz)	Z_{in} (Ω)
-2.0	9.67	-10.6	1.83	----	----
-1.8	9.51	-13.5	1.5	----	----
-1.6	9.40	-18.74	1.26	552	(39.68,1.73)
-1.4	9.34	-34.16	1.033	705	(50.65,1.77)
-1.2	9.23	-16.00	1.33	442	(66.55,-3.3)
-1.0	9.18	-10.65	1.830	----	----

At the resonance frequency 9.346 GHz, the simulation result of the surface current distributions on optimum patch antenna is shown in Fig. (10). This figure shows that the current distribution on the optimum patch has one resonance frequency. Moreover, the current distribution has

symmetrical behavior on the upper and lower half of optimum patch, excluded the feed point. Also, the density distribution of surface current is strong on the edges of the optimum patch.

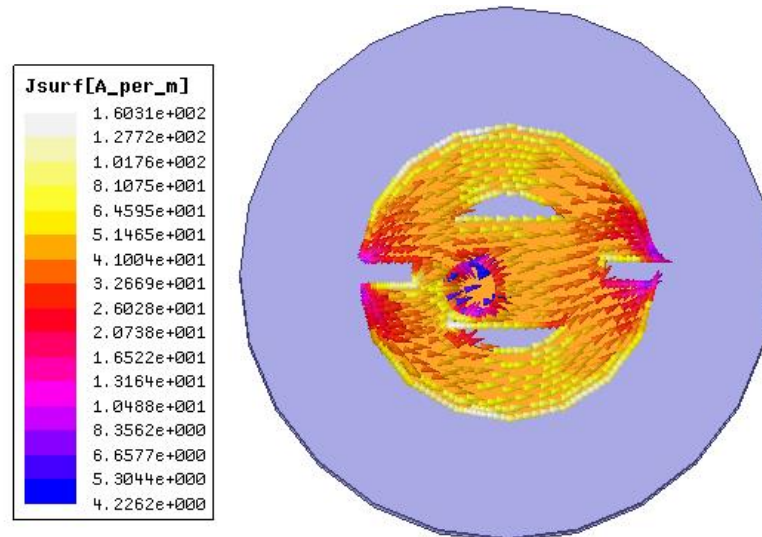

Figure 10: Simulation results of the surface current distributions on optimum antenna design.

4. Conclusions

New patch antenna is designed and simulated based on the circular microstrip antennas using etched slots on this circular patch. The shapes of these slots are rectangular and crescent and the proposed antenna is fed by a coaxial line feed. The Ansoft High Frequency Structure Simulator is used to design and simulated the new patch antenna. This antenna operates in X-band frequency at resonance frequency 9.346 GHz with bandwidth of return loss of 705 MHz and gain 7.843 dB. It can be concluded that the proposed antenna useful for many applications that is required for X-band.



References

- [1] R.A . Mutashar, W.A.G. Al-Tumah, A.S. Tahir, Design and Simulation of Triple Band Circular Patch Microstrip Antenna Based on Shape of Ring and Rectangular Slots, Open Access J Sci Technol, 3(2020) 245-252
- [2] J.W. Kim, T.H. Jung, H.K. Ryu, J.M. Woo, C.S. Eun and D.K. Compact multiband microstrip antenna using inverted-L-and T-shaped parasitic elements IEEE Antenn Wirel. Pr., 12 (2013) 1299-1302
- [3] W.A. Godaymi, A.K. Mohammed ,Z.A. Ahmed, Determination of Surface Currents on Circular Microstrip Antennas, J Electromagn Eng Sci., 12 (2012)260–270
- [4] B. Yildirim, B.A. Cetiner, Enhanced gain patch antenna with a rectangular loop shaped parasitic radiator, IEEE Antenn Wirel. Pr., 7 (2008) 229-232
- [5] W.A.G. Al-Tumah, R.M. Shaaban, A.P. Duffy , Design, simulation, and fabrication of a double annular ring microstrip antenna based on gaps with multiband feature. . Eng. Sci. Technol., (2021) 1-10
- [6] I. Zivkovic, K. Scheffler, A new inovative antenna concept for both narrow band and UWB applications ,Prog. Electromagn. Res.,139 (2013) 121-131
- [7] W.A.G. Al-Tumah, R. Shaaban, A. Tahir, Design, simulation and measurement of triple band annular ring microstrip antenna based on shape of crescent moon. AEU-Int. J. Electron. Commun .,117(2020) 1-23
- [8] Z. Liu, P. Wang, Z. Zeng, (Enhancement of the gain for microstrip antennas using negative permeability metamaterial on low temperature co-fired ceramic (LTCC) substrate, IEEE Antenn Wirel. Pr., 12(2013) 429-432.
- [9] W.A.G. Al-Tumah, R. Shaaban, Z.A. Ahmed Designing a Microstrip Patch Antenna in Part of Ultra-Wideband Applications, Baghdad Sci. J.,17(2020)1216-1216
- [10] A.R. Albino,C.A. Balanis, Gain enhancement in microstrip patch antennas using hybrid substrates. IEEE Antenn Wirel .Pr.,12 (2013) 476-479
- [11] W.A.G. Al-Tumah, R. Shaaban, A. Tahir and Z Ahmed, Multi-forked microstrip patch antenna for broadband application, J. Phys.: Conf. Ser. 1294, (2019)1-7
- [12] L.A.R. Ramirez, J.C.A. Santos, Design, simulation, and optimization of an irregularly shaped microstrip patch antenna for air-to-ground communications, Int.J. Antenn Propag. , (2017)1-9
- [13] A. Mohammed, W.A.G. Al-Tumah, R. Malallah, Design of Wraparound Microstrip Antenna using the Method of Moment, Open Access J Sci Technol, 3(2020) .266-273



- [14] P. Khanna, K. Shinghal, A. Kumar, Multi-band annular ring microstrip antenna with defected ground structure for wireless communication, *Int J Comput Appl*, 135 (2016) 19–25
- [15] R. M Shaaban, Z.A. Ahmed, W.A. Godaymi, Radiation patterns account of a circular microstrip antenna loaded two annular , *J. Nat. Sci. Res.*, 6(2016)71-81
- [16] Mohammed, R. Malallah, W.A.G. Al-Tumah, Modulation Designed for Wraparound Microstrip Antenna, *J of Misan Researchers*, 16 (2020) 207-214
- [17] R. Malallah, R. Shaaban, W.A.G. Al-Tumah , A dual band star-shaped fractal slot antenna: Design and measurement , *AEU-Int. J. Electron. C.*, 127 (2020)1-9
- [18] C.L. Mak, H. Wong, K.M. Luk, High-gain and wide-band single-layer patch antenna for wireless communications *IEEE T. Veh. Technol.*, 54 (2005) 33-40
- [19] R. M Shaaban, Z.A. Ahmed, W.A. Godaymi , Design and analysis for circular microstrip antenna loaded by two annular rings , *Glob J Comput Sci Technol C.*, 17(2017)31-35
- [20] S.B. Yeap, Z.N. Chen, Microstrip patch antennas with enhanced gain by partial substrate removal, *IEEE T. Antenn Propag.*, 9 (2010) 2811-2816
- [21] W.A.G. Al-Tumah, R. Shaaban, and Z.Ahmed, A modified E-shaped microstrip patch antenna for dual band in x-and ku-bands applications ,*J. Phys. Conf. Ser.* 1234, (2019) 1-8
- [22] K. Mandal, P.P. Sarkar, High gain wide-band U-shaped patch antennas with modified ground planes , *IEEE T. Antenn Propag.*, 61(2013) 2279-2282.
- [23] Z.A. Ahmed, W.A. Godaymi, Spherical array of annular ring microstrip antennas, *Bas. J.Sci. (A)*, 28(2010)110-123
- [24] H.A. Majid, M.K. Abd Rahim, T. Masri, Microstrip antenna's gain enhancement using left-handed metamaterial structure, *Prog. Electromag. Res. M*, 8(2009)235-247
- [25] Z. Park, C. Li, J. Lin, A broadband microstrip antenna with improved gain for noncontact vital sign radar detection, *IEEE , IEEE Antenn Wirel. Pr.*, 8 (2009)939-942
- [26] K. Xu, Y. Liu, L. Dong, L. Peng, S .Chen, F. Shen , Printed multi-band compound meta-loop antenna with hybrid-coupled SRRs, *IET Microw. Antenna P.*,12(2018) 1382-1288
- [27] P. Saha, A Singh, V Pandey, B. Kanaujia, M. Khandelwal, Design and analysis of UWB circular ring two element microstrip patch antenna array with notched band for modern wireless applications ,*Microw Opt Techn Let.*, 56 (2015) 2067-2072



- [28] M. Sharma, H. Singh, Design and analysis of substrate integrated waveguide for high frequency applications, Recent Trends in Programming languages, 6 (2019)1-5
- [29] M. Sharma, S. Singh, D. Khosla, S. Goyal, A.K. Gupta, Waveguide diplexer: design and analysis for 5G communication, 5th IEEE Int. Conf. PDGC, (2018)586-590
- [30] D. M. Pozar, Microwave engineering, John Wiley & Sons , 4th Edition, 2011
- [31] R.M Shaaban, Z.A. Ahmed, W.A. Godaymi, Contribution adjacent modes for circular microstrip antenna loaded by two annular rings, J of Kufa-physics, 10(2018)44-52
- [32] J.J. Tiang , M.T. Islam, N. Misran, J.S. Mandeep, Circular Microstrip Slot Antenna For Dual Frequency Rfid Application ,Prog. Electromagn. Res., 120(2011)499–512



تصميم هوائي دائري محفور عالي الكسب لتطبيقات الحزمة x-band

ريام احمد مطشر، عقيل سامي طاهر، وائل عبد اللطيف كديمي الطعمة

المستخلص

في هذه الدراسة ، تم تصميم ومحاكاة تراكيب جديدة من الهوائيات الشريطية الدائرية التي تعمل ضمن ترددات حزمة x-band وذلك من خلال حفر شقوق على الرقعة المشعة. إن هذه الشقوق تأخذ أشكال مستطيلة وهلالية وبأحجام مختلفة. يتم تغذية تصاميم الهوائيات المقترحة بخط تغذية محوري. ان الهوائيات المصممة تمت محاكاتها ودراستها من أجل الحصول على الأداء الأمثل لها وذلك باستخدام برنامج المحاكاة HFSS. إن نتائج المحاكاة التي تم الحصول عليها كانت متمثلة بمعامل الانعكاس وممانعة الادخال والتحصيل والهياكل الاشعاعية اضافة الى كثافات التيارات السطحية. من خلال نتائج المحاكاة وُجد بأن تصميم الهوائي الأمثل يعمل بتردد رنين مقداره 9.346 GHz ويمتلك عرض نطاق ترددي 705 MHz وهو ضمن تطبيقات حزمة الرادار x-band. لذلك فإن التصميم الأمثل في هذا العمل مناسب للعديد من التطبيقات في نظام الاتصالات اللاسلكية الحديثة.

